

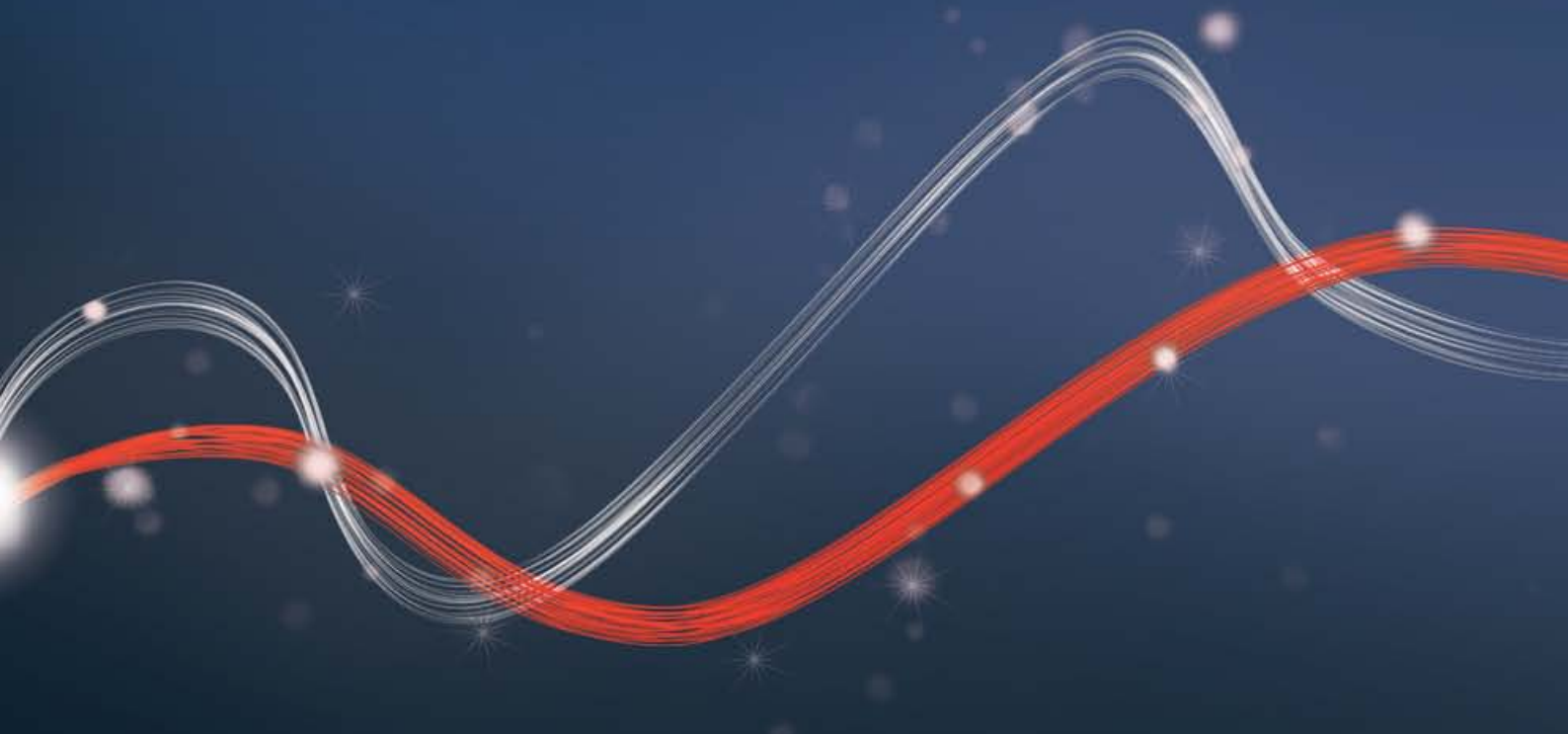

Be ahead



B EBA WI-FI GATEWAY



• RANGE

• PLUSES

• TECHNICAL CHARACTERISTICS

• MAIN FUNCTIONS

• DISCOVER U-LINK



Empowered by
U-LINK

PRODUCT DESCRIPTION

The B-eba Wi-Fi expansion card connects to the web the device where it is installed, via wi-fi protocol. Through the U-control management app, the B-eba card is registered on the home wi-fi network and thus allows the operator to be remotely managed. All U-Link protocol compatible BFT devices can be managed with U-control, whether they are operators, central units or receivers; therefore also automation devices by other brands can be remotely controlled. The U-control app is free and available for Android and IOS smartphones.

B EBA Wi-Fi GATEWAY | |

|  | Code | Name | Description |
|--|---------|---------------------|---|
| | P111494 | B EBA Wi-Fi gateway | Expansion card that allows the connection of a U-link device to a home Wi-Fi network for remote control via U-control app |

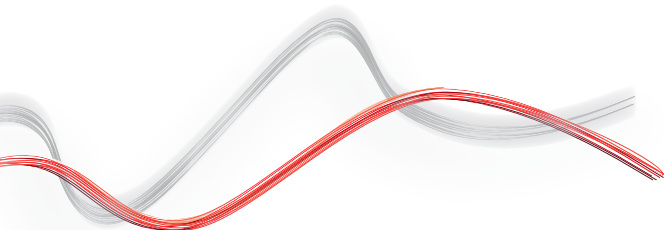

· RANGE

· **PLUSES**

· TECHNICAL CHARACTERISTICS

· MAIN FUNCTIONS

· DISCOVER U-LINK

PLUSES

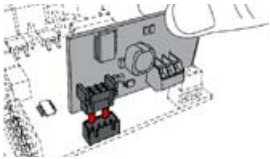

Plug and play: the B-eba Wi-Fi expansion card connects directly to the U-link central units; for wi-fi connection, simply insert the B-eba into the dedicated slot and follow the U-control App instructions.



Immediate diagnosis: lighting up (steady or flashing) of the two LEDs indicates if the B-eba wi-fi is in the network search phase and when the wi-fi connection is active.



Download the U-control app: thanks to this app (available for Android and IOS), you can control the automation remotely, monitor gate status (open, closed, moving), invite other users to use the automation, create scenarios, and contact your installer directly in case of need, automatically sending the last error detected by the central unit.

· RANGE

· PLUSES

· TECHNICAL CHARACTERISTICS

· MAIN FUNCTIONS

· DISCOVER U-LINK

TECHNICAL CHARACTERISTICS

| | B EBA Wi-Fi gateway |
|--------------------------|---|
| Ambient conditions (min) | -20 °C |
| Ambient conditions (max) | 50 °C |
| Band | 2400 - 2483.5 MHz |
| Dimensions | 42x29 (HxL) mm |
| Wi-Fi | 802.11 : b/g/n. Bit rate: 72.2 Mbps. Security: OPEN, WPA2/ WPA Personal and WEP |



Dimensions

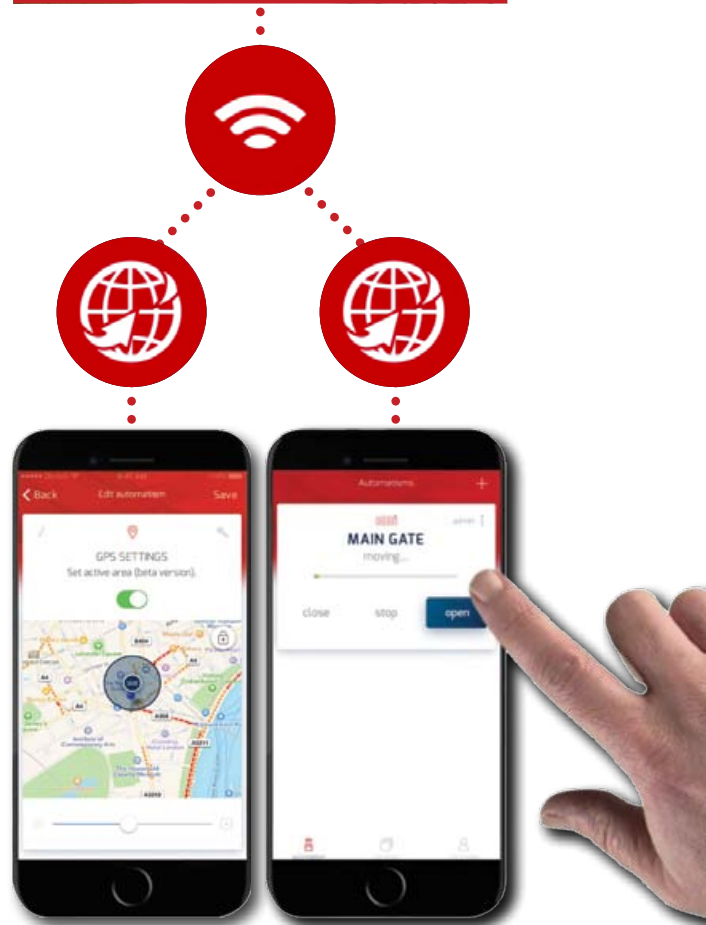
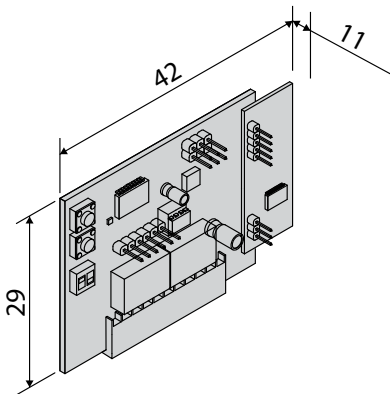

· RANGE

· PLUSES

· CONTROL PANEL
· TECHNICAL CHARACTERISTICS

· MAIN FUNCTIONS

· DISCOVER U-LINK

| | Name | Description |
|---|-----------|--|
|  | U-Control | App for the remote management and control of a U-Link device. The device connects to the home Wi-Fi network thanks to the B-Eba Wi-Fi. |

MAIN FUNCTIONS

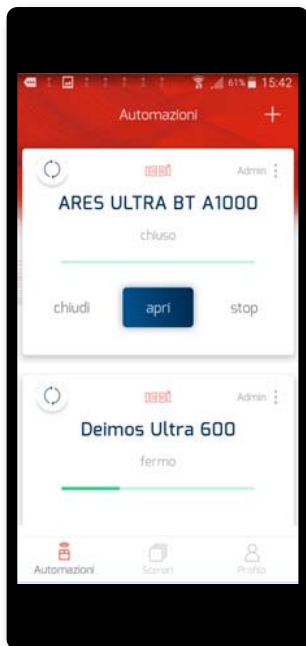

You can open, close or stop a U-link device remotely or locally with just a touch

You can instantly check gate status (open / closed / moving) using the dedicated button.

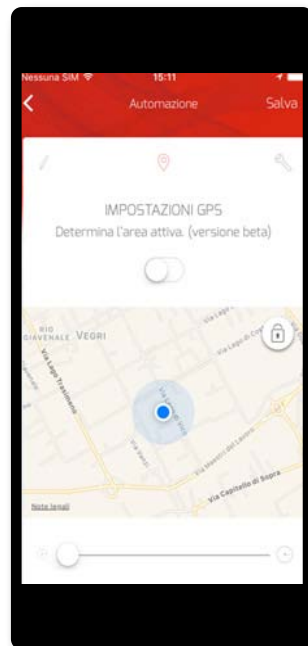

On the IOS version, GPS technology can be used to open and close the gate automatically when the owner approaches

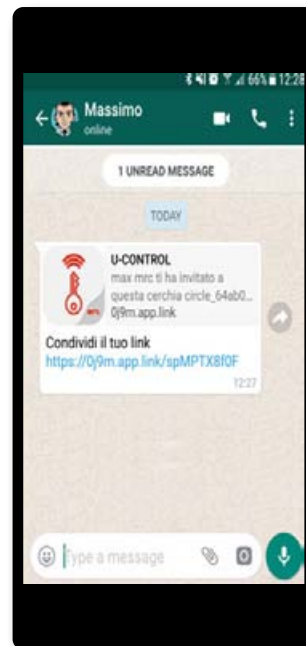

Other users (up to 5) can be invited to use the same gate. Invited users will be able to control the gate with the rules set by the administrator. The system sends the administrator a notification for each operation performed by the invited users; this feature can be deleted from your smartphone settings

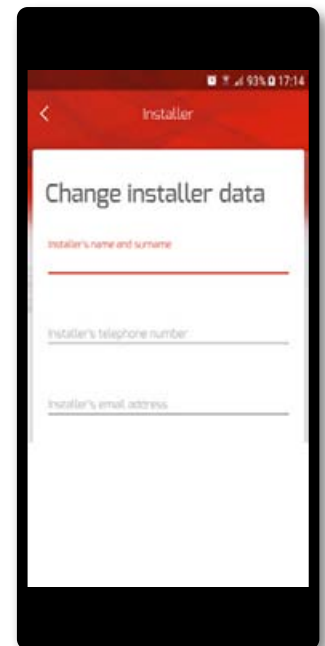

You can enter the name and references of your installer in the U-control app. In case of a system failure, the installer can be contacted directly from the U-control app, emailing also the last error detected by the central unit

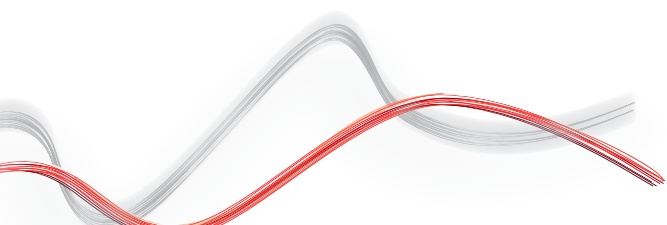



· RANGE

· PLUSES

· TECHNICAL CHARACTERISTICS

· MAIN FUNCTIONS

· DISCOVER U-LINK

What is U-Link?

The innovative technology that gives you new power

An exclusive Bft innovation: U-Link (Universal Link) is an exclusive Bft platform that allows the creation of technological ecosystems. In Home Access Automation it allows communication with all home access automation devices, by any brand. So you save time and can control everything with ease, without any worries.

It's intuitive

Easy to install and use

It's scalable

It allows an unlimited number of devices to be added

It's flexible

It allows the creation of groups of interconnected products

It's practical

It works with or without a web connection

It's functional

Parameters can be controlled remotely via dedicated applications

- RANGE
- PLUSES
- TECHNICAL CHARACTERISTICS
- ACCESSORIES
- DISCOVER U-LINK

All in one scheme: discover this amazing technology

A unique platform allowing the creation of technological ecosystems offering a wide range of solutions for different sectors.

Thanks to the B-Eba cards and the Clonix U-Link receiver, this proprietary platform featured by Bft products adapts to any protocol and access automation product (even BFT non-native U-Link or non-BFT products), and is used in various sectors. Each device thus becomes smart and can be interconnected with other systems, thanks to a language that becomes universal.

U-Base 2

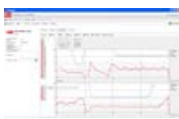

Software to install and easily and comfortably carry out maintenance and identify any malfunction of U-link compatible operators.

U-SDK



U-SDK is the innovative application that can make Bft automation systems compatible and easily integrated with a BMS network for the supervision of buildings.



Magistro

An innovative and easy to install system for easily managing all home automation systems.



U-Control

U-Control is the application that helps the quick and easy integration of BFT automation systems in large building management systems.



Blue-Entry

Technology abreast of the times and attentive to daily needs: thanks to the use of U-link the house gate can now be opened with just your smartphone.



Clonix U-Link

Allows the connection of non-native U-Link products or non-Bft products to U-Link systems.

Bft operators, non-native U-Link products or a product belonging to other brands: can they be connected to U-Link? Yes, thanks to the Clonix receivers. Accessories that know no limits.



B-eba

A direct line with your operators.

B-eba expansion cards allow the connection of external devices, such as PCs, smartphones and tablets, to a Bft operator or Clonix receiver, or the connection of several Bft products in a U-Link network. These accessories integrate with U-Link technology and Bluetooth, Z-Wave and TCP/IP protocols, as well as the RS485 serial connection. A device that fully translates what Bft means for interconnectivity.

